

Directional control valves  
manual operated poppet 2-way normally open  
Special cavity, 019-E

VMI-8A-2A-06-NA-VU

OD.55.12.19.17 - Z

**RE 18326-04**

Edition: 01.2010

Replaces: 01.2006

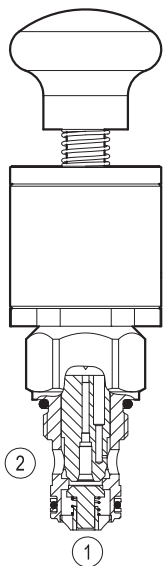

▼ Version 12

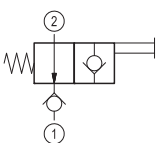

**Technical data**

<b>General</b>	
Weight	0.27 kg (0.6 lbs)
Installation orientation	Optional
Ambient temperature range	-30 to 60 °C (-22 to 140 °F)
<b>Hydraulic</b>	
Max. operating pressure	350 bar (5000 psi)
Max. flow	40 bar (11 psi)
Max. internal leakage	20 drops/min.
Fluid temperature range	-20 to 80 °C (-4 to 176 °F)
Fluids: Mineral-based or synthetics with lubricating properties at viscosities of 20 to 380 mm <sup>2</sup> /s (cSt)	
Installation torque	39 - 51 Nm (29 - 38 ft-lbs)
Recommended degree of fluid contamination	Nominal value max. 25 µm (NAS 8) ISO 4406 19/17/14
Special cavity	019-E see 18325-75
Lines bodies and standard assemblies	Please refer to section "Hydraulic integrated circuit" or consult factory
Seal kit – version 11	code           RG19E201053010 material no.   R934003561
Other technical data	See data sheet 18350-50
Only for cam-operated valves:	
Operating stroke	3 mm (0.12 in)
Max. overstroke	0.5 mm (0.02 in)

**Ordering code**

<b>OD.55</b>	<b>12</b>	<b>19</b>	<b>17</b>	<b>Z</b>
--------------	-----------	-----------	-----------	----------

Directional control valves  
manual operated poppet 2-way  
normally closed

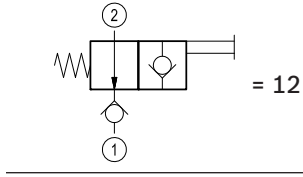

Hand-operated

00 =

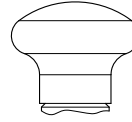

Special cavity: 019-E

**Preferred types**

Type	Material number
OD551219170000	R934003670

Type	Material number

**Characteristic curves**

**Version 11**

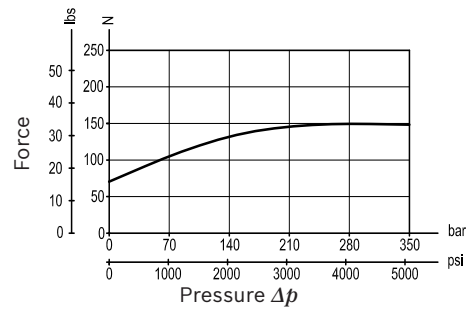
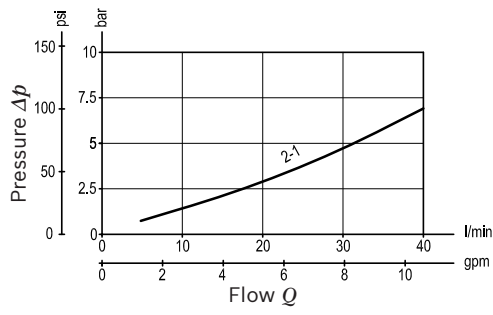

## Dimensions

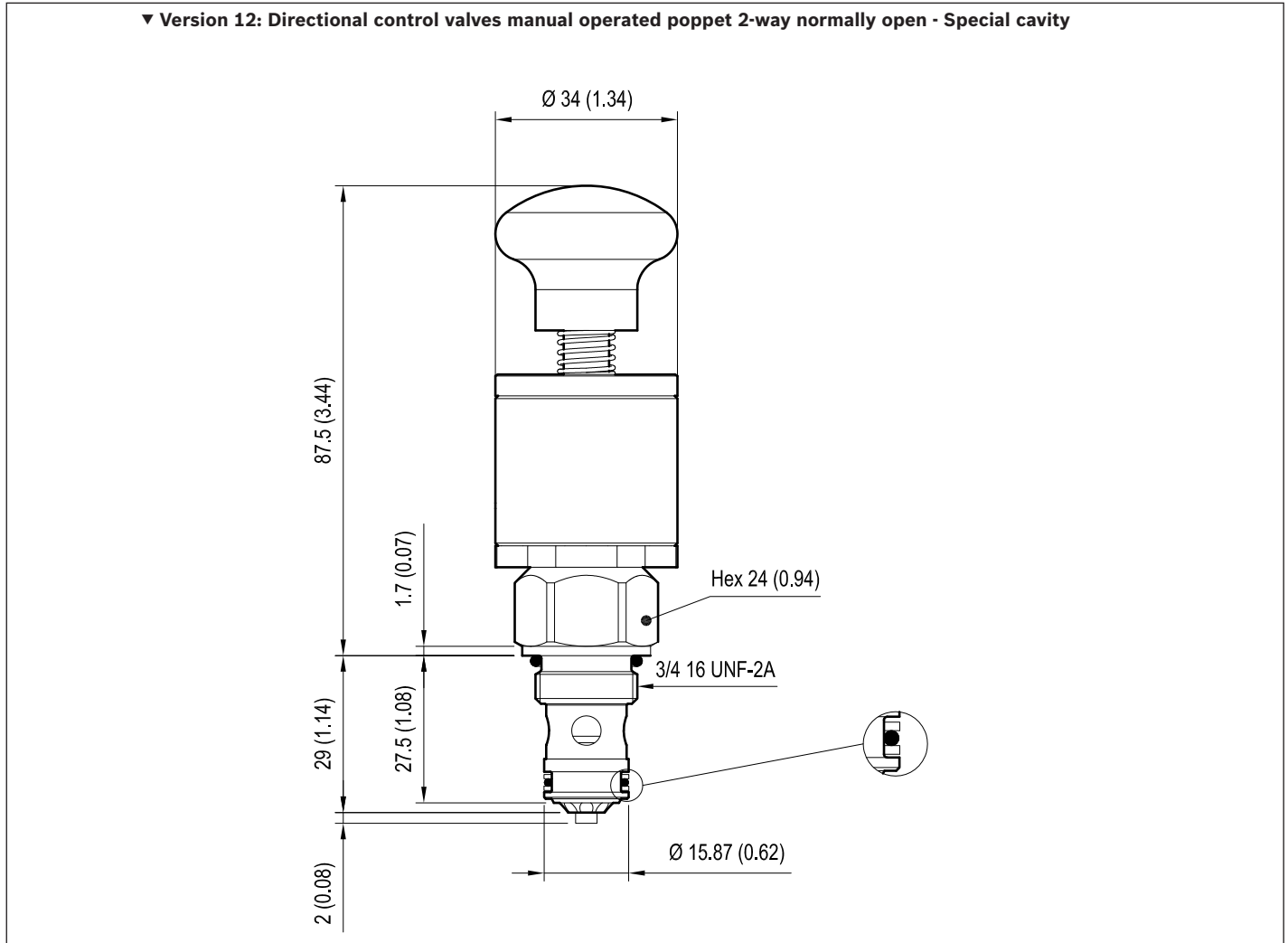
**Bosch Rexroth Oil Control S.p.A.**

Via Leonardo da Vinci 5  
P.O. Box no. 5  
41015 Nonantola – Modena, Italy  
Tel. +39 059 887 611  
Fax +39 059 547 848  
compact-hydraulics-cv@boschrexroth.com  
www.boschrexroth.com/compacthydraulics

© This document, as well as the data, specifications and other information set forth in it, are the exclusive property of Bosch Rexroth Oil Control S.p.a.. It may not be reproduced or given to third parties without its consent. The data specified above only serve to describe the product. No statements concerning a certain condition or suitability for a certain application can be derived from our information. The information given does not release the user from the obligation of own judgment and verification. It must be remembered that our products are subject to a natural process of wear and aging. Subject to change.